

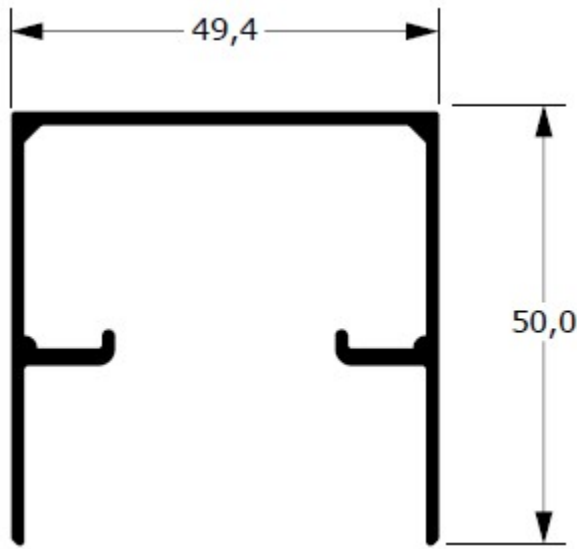

CAMAL ALUMÍNIO |||

BOX LISO E BOX TEMPERADO



BX-010

0,617 kg/m

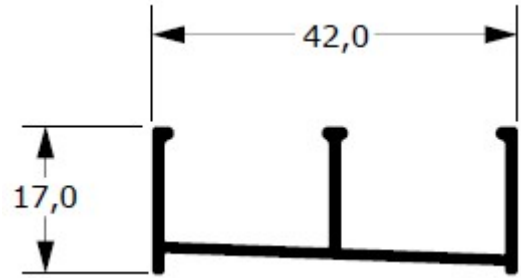

BX-025

0,334 kg/m

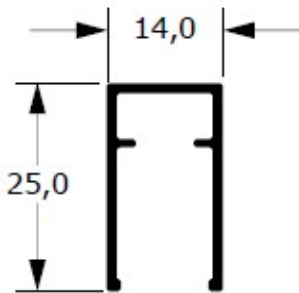

BX-052

0,228 kg/m

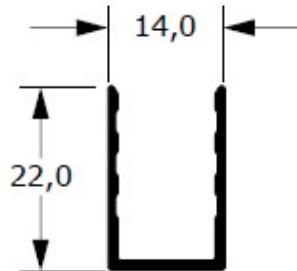

39-956

0,166 kg/m

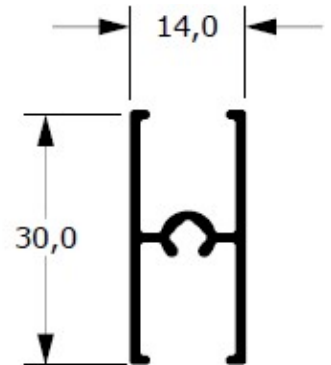

BX-002

0,320 kg/m

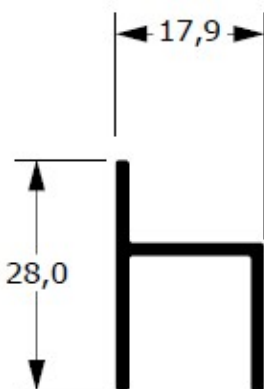

BX-006

0,263 kg/m

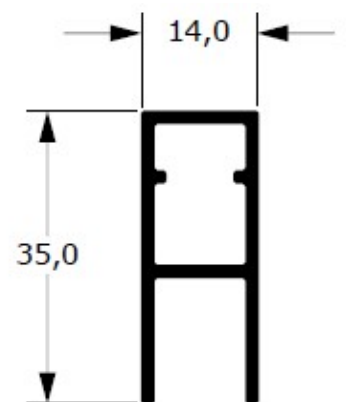

BX-001

0,420 kg/m

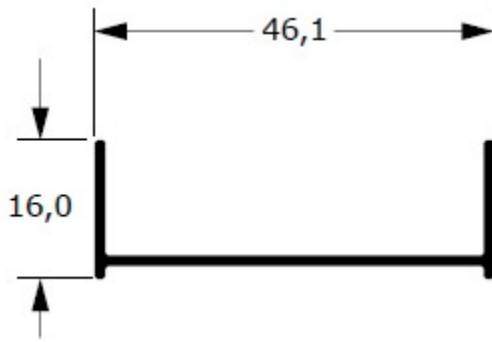

CL-017

0,245 kg/m

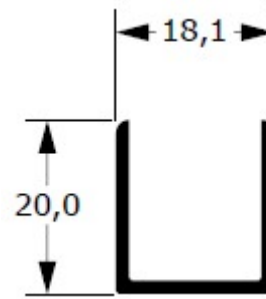

BX-012

0,221 kg/m

BX-007

0,217 kg/m

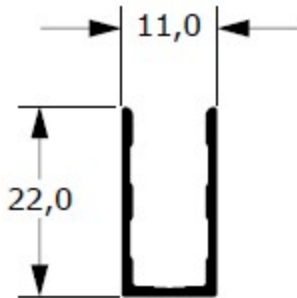
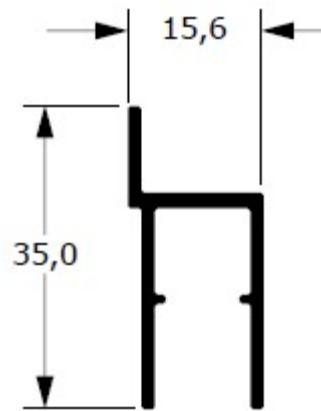

PU-315

0,167 kg/m

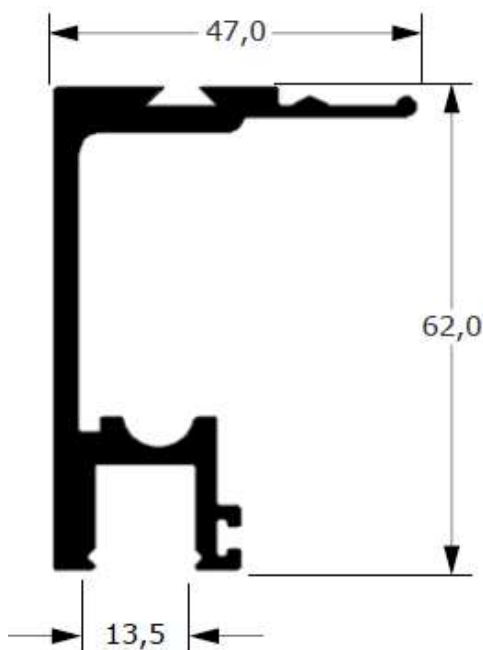

BX-215

1,278 kg/m

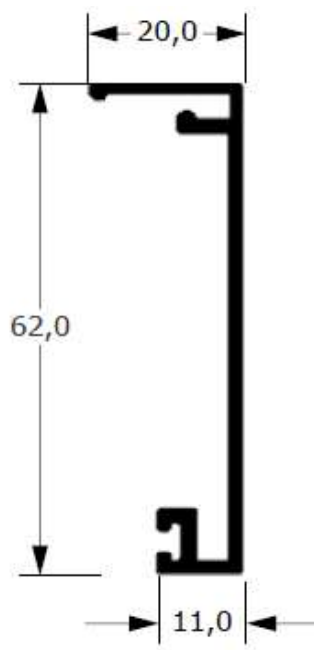

BX-216

0,435 kg/m

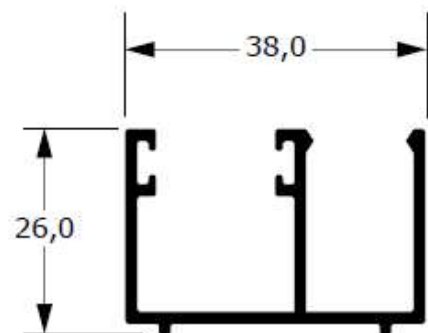

BX-214

0,404 kg/m

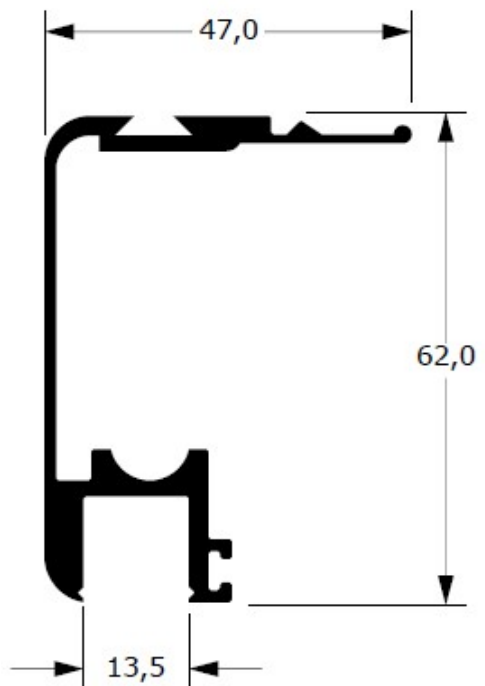

BX-215A
0,971 kg/m

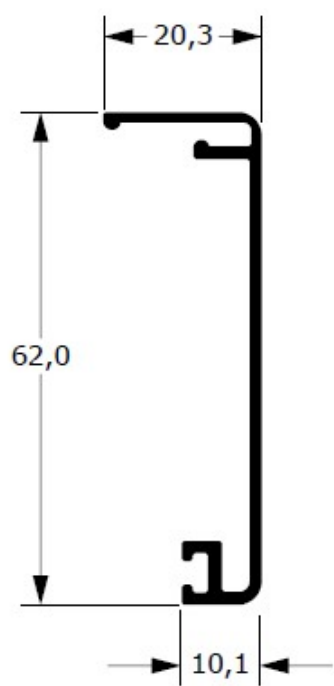

BX-216A
0,433 kg/m

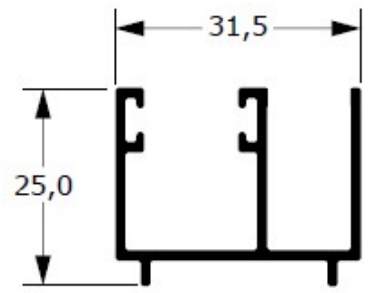

BX-213
0,465 kg/m

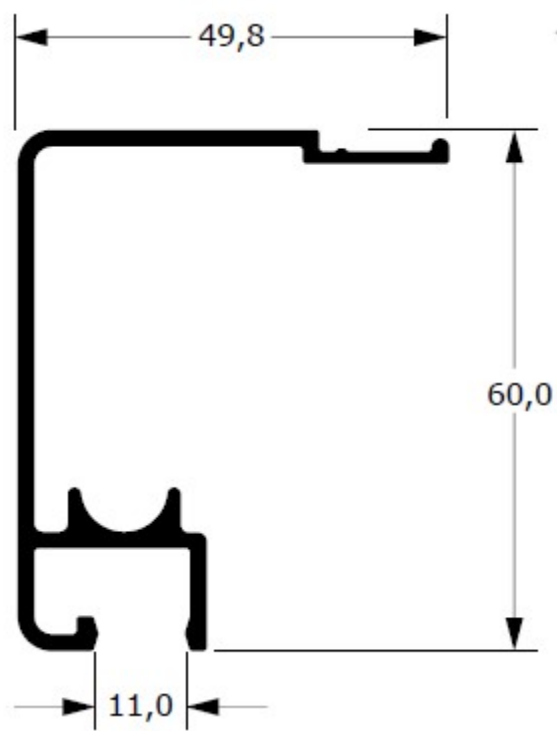

BX-229A
0,824 kg/m

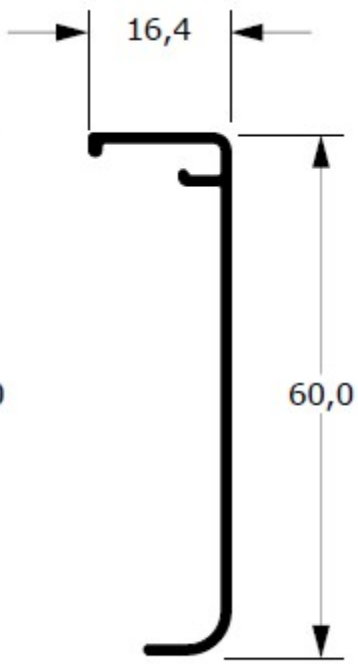

39-957
0,264 kg/m

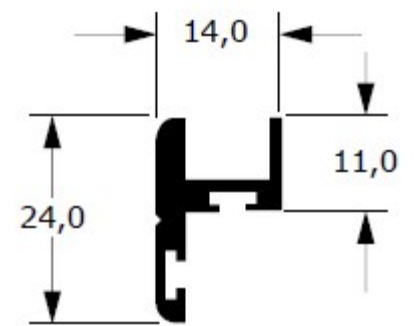

BX-209
0,276 kg/m

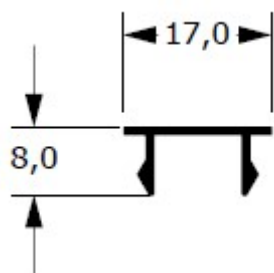

CL-022
0,093 kg/m

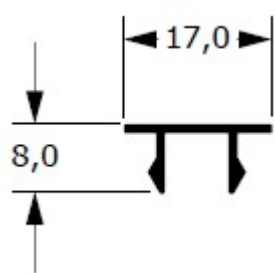

CL-021
0,094 kg/m

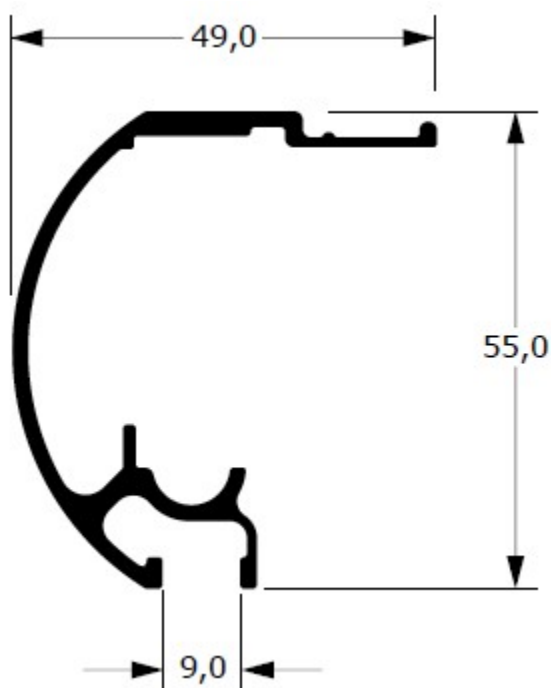

39-493
0,729 kg/m

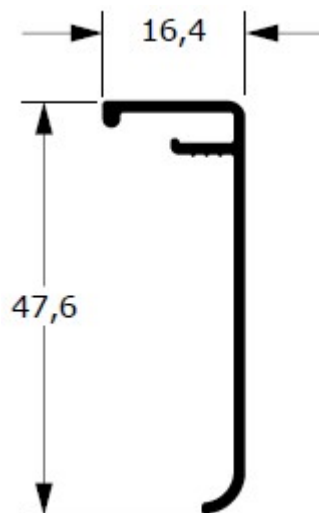

39-492
0,261 kg/m

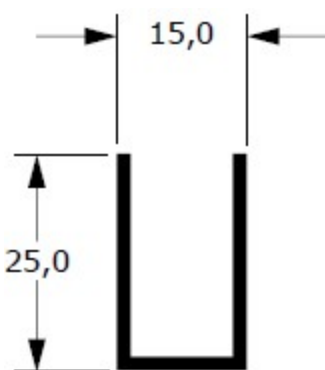

PU-316
0,268 kg/m

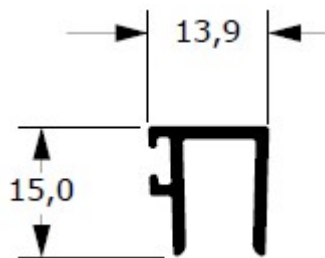

39-137
0,177 kg/m

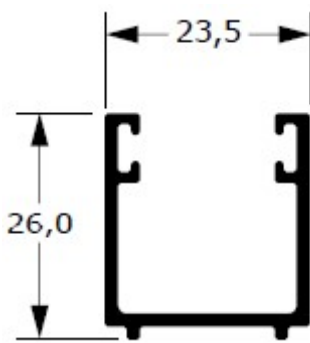

U-1108
0,342 kg/m

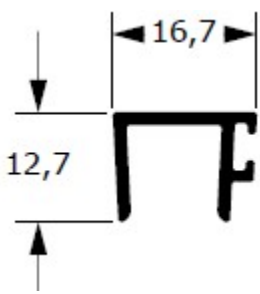

39-143

0,170 kg/m

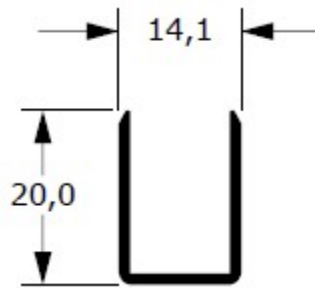

PU-316A

0,175 kg/m

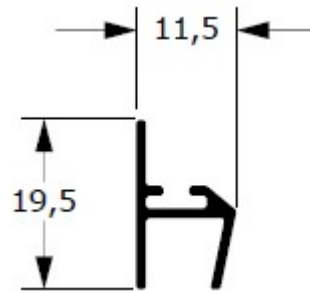

BX-209A

0,137 kg/m

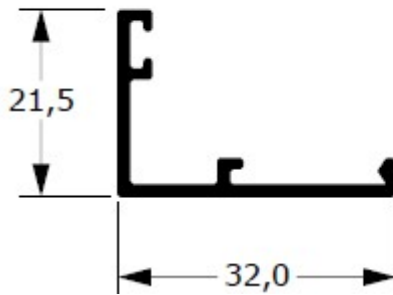

32-110

0,264 kg/m

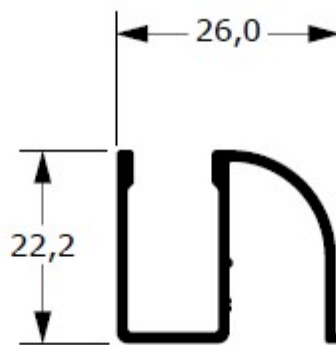

BX-003

0,309 kg/m

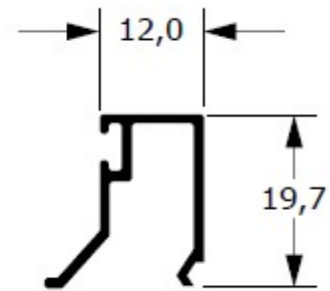

32-100

0,179 kg/m

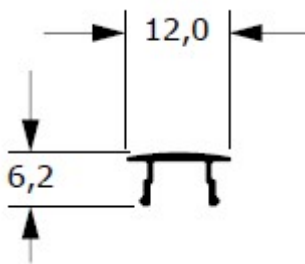

CL-021A

0,055 kg/m

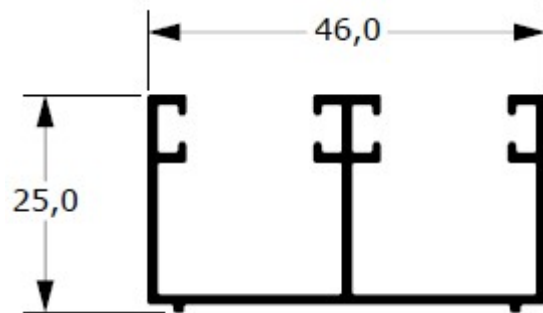

39-1271

0,489 kg/m