

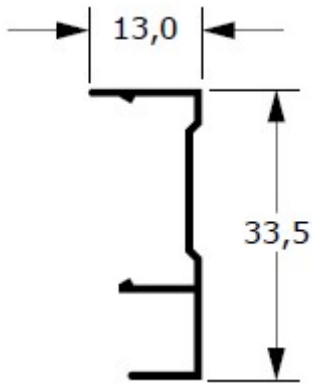

CAMAL ALUMÍNIO |||

ARREMATES E SOLEIRAS



CM 111

0,156 kg/m

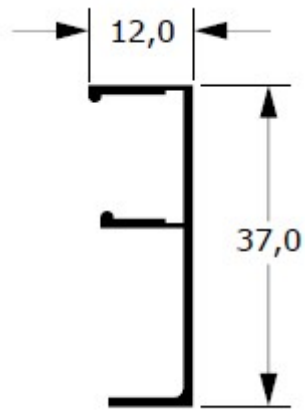

MP 347

0,197 kg/m

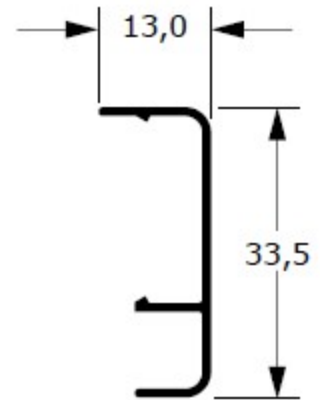

CM 130

0,162 kg/m



MN-014

0,214 kg/m



CX-171

0,265 kg/m

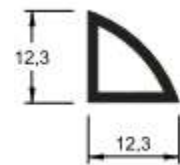

2165

0,125 kg/m

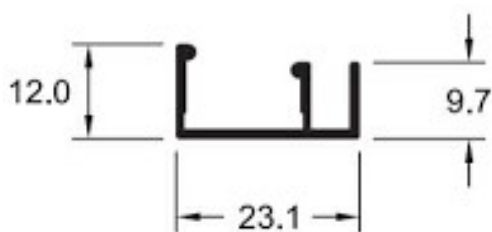

ME-092

0,096 kg/m

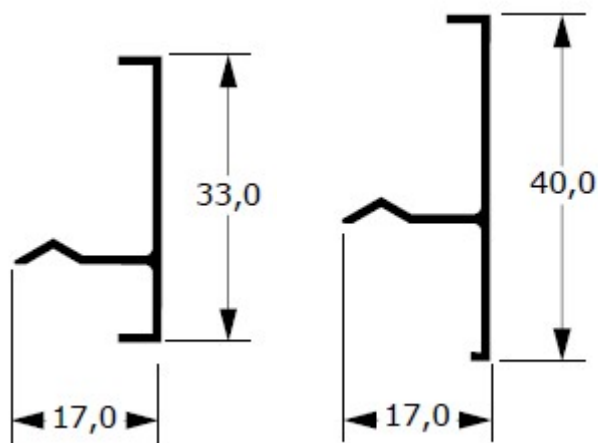

CM 007

0,157 kg/m

CM 006

0,168 kg/m

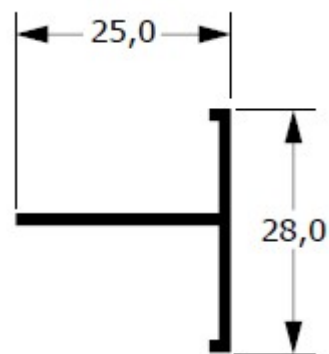

CM 008

0,203 kg/m

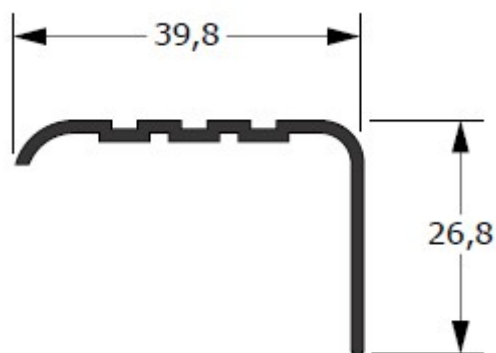

ME-013

0,268 kg/m

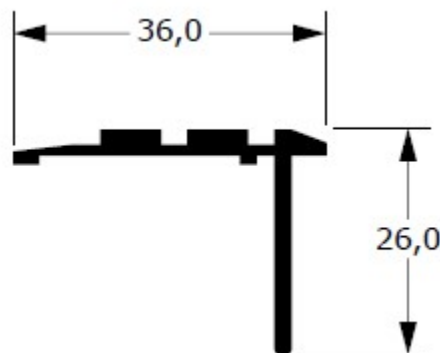

CM-029

0,339 kg/m

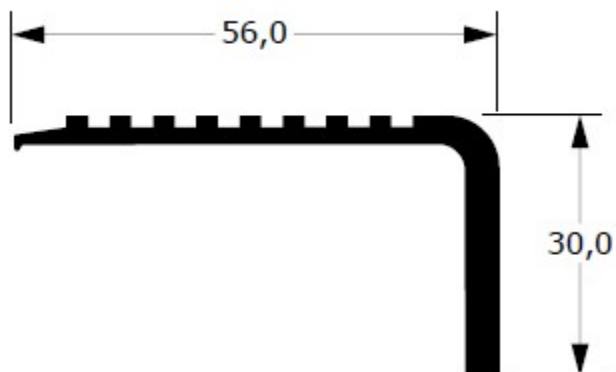

CA-001

0,697 kg/m

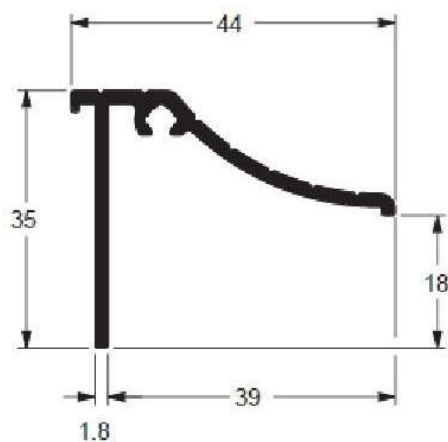

CM-169

0,431 kg/m

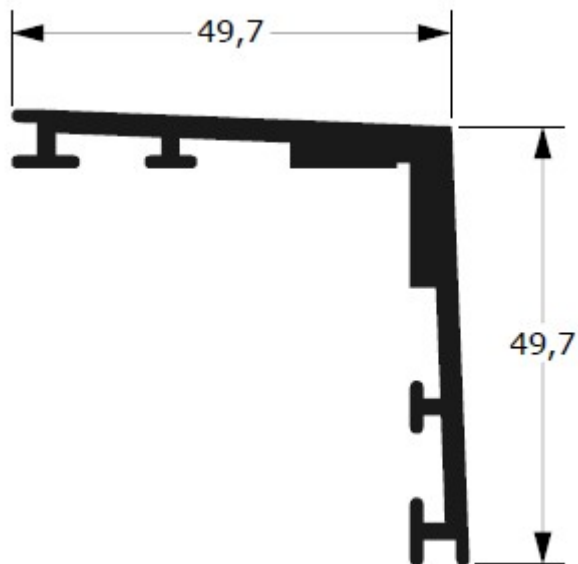

CL-006

1,006 kg/m

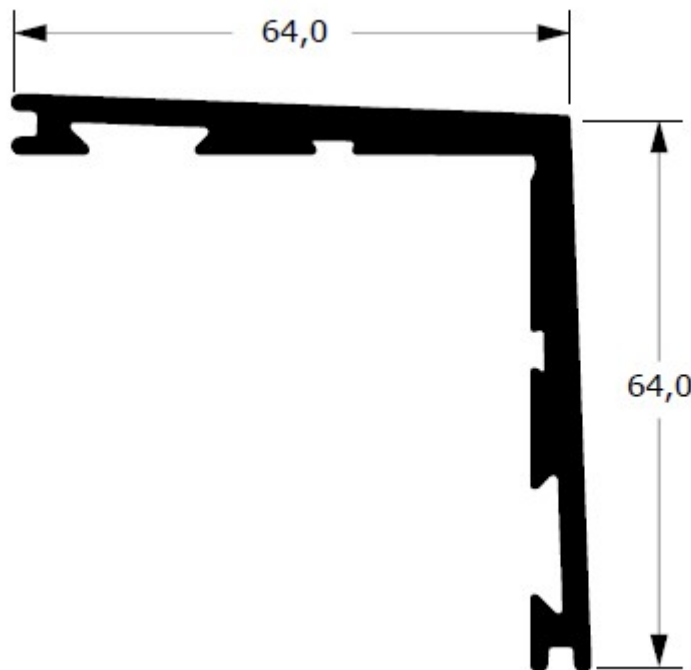

CL-009

1,585 kg/m

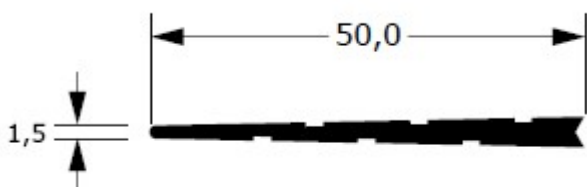

CL-011

0,315 kg/m

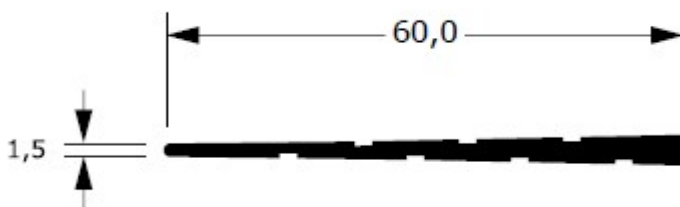

CL-010

0,389 kg/m